



Smartphone Eye Imaging Adaptor QuikVue Plus VPA-200

Eye Capture at Your Palm

Product Design Concept

It is well acknowledged that imaging is playing a more and more important role in ophthalmology diagnosis. QuikVue Plus is a smartphone adaptor designed especially for anterior segment imaging. It provides 10x magnification which meets the basic eye examination demand for optometrists, general practitioners, pediatricians, veterinarians, etc. The specially designed optical lens enable QuikVue Plus to capture clear anterior images for primary eye care examination and telemedicine.

Clinical Applications



General eye check



Immobile patient check



Children patient check



Emergency check



Elderly patient Check



Pet eyecare check



White and Blue Illumination

QuikVue Plus provides both white and blue illumination respectively. The white LED projects warm white light which is similar to slit lamp's halogen illumination. There are two levels of white illumination available to meet different brightness demand during examination. The blue illumination can be used to capture fluorescein images to assist diagnosis with corneal staining and contact lens fitting, etc.



Power Management

QuikVue Plus applies mini Li-ion rechargeable battery. It can be recharged through a Type C cable. There is one light indicator next to the Type C charging port. When the power recharging is finished, the indicator light will turn from blue to green.

The switch button has blue light on when working normally. If the power is low, the light will flicker to remind clinicians to do recharge.



Integrated Yellow Filter

QuikVue Plus is equipped with an integrated yellow filter. The flipable yellow filter making it easy for clinicians to take enhanced fluorescein images with cobalt blue illumination. This function is especially useful in lens fitting, cornea ulcer imaging, tear film break up time examination, ect.



Smartphone Compatibility

Thanks to the air cushion design, QuikVue Plus is able to attach on most of the phones in the market firmly. Clinicians need to align QuikVue Plus lens with smartphone's main camera. The requirements for the main camera location is as below:

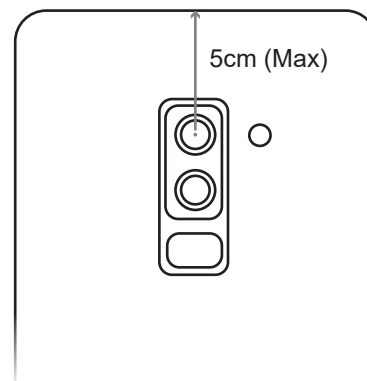
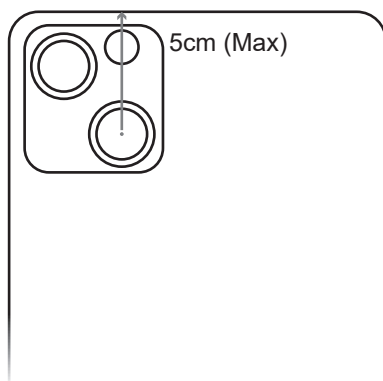

Working Application

QuikVue plus can work with smartphone default camera app or VisuScience developed VisuDoc ophthalmic case management app. VisuDoc can be downloaded from both App store and Google play store.

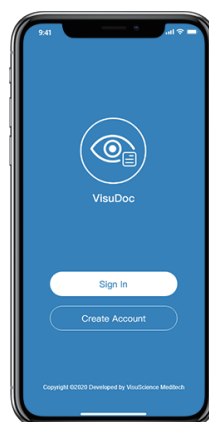
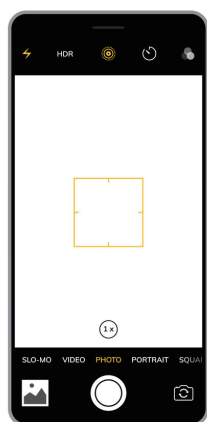
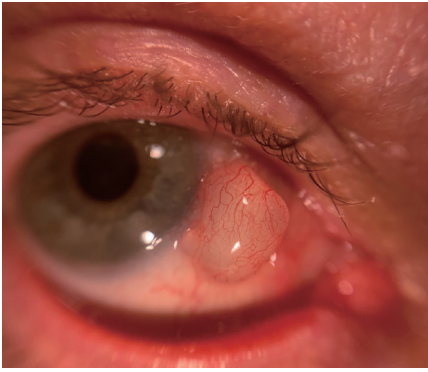
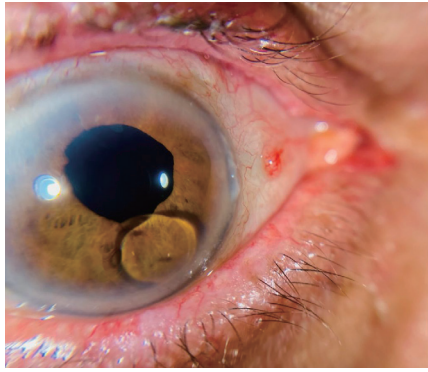

Image Showcase



Corneal Cyst



silicone oil migration



Eye Lid



Air Descemetopexy

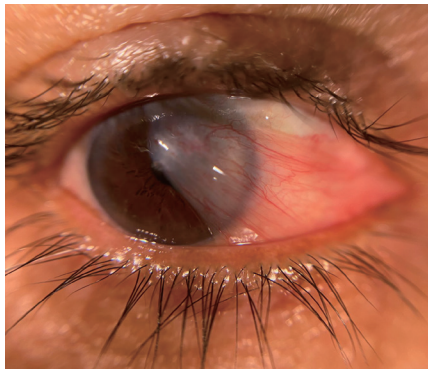

Pterygium

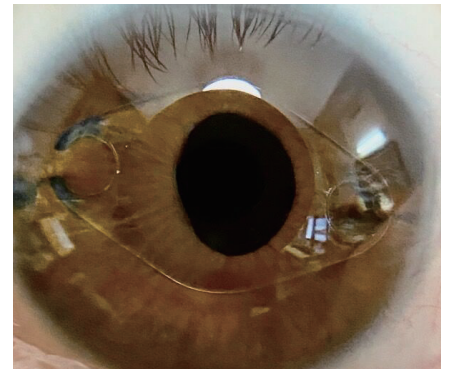

ICL Implant

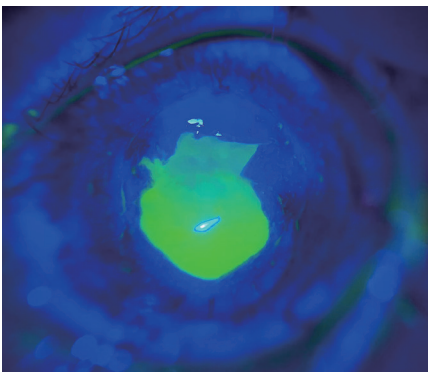

Corneal Ulcer

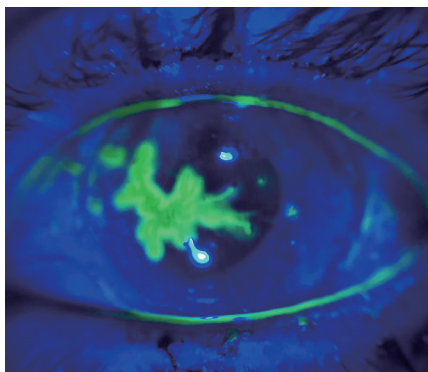

Dendritic ulcer

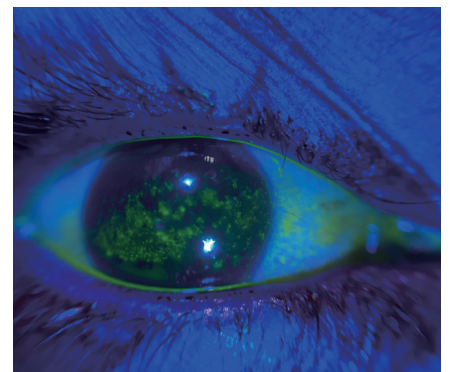

Superficial Punctate Keratitis

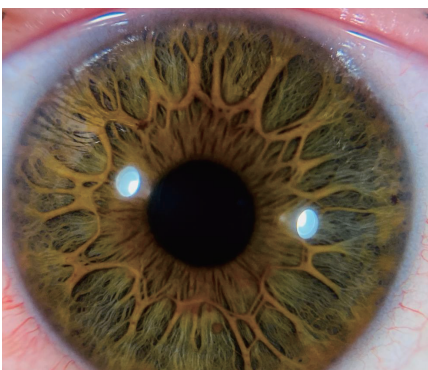

Flower Iris Pattern

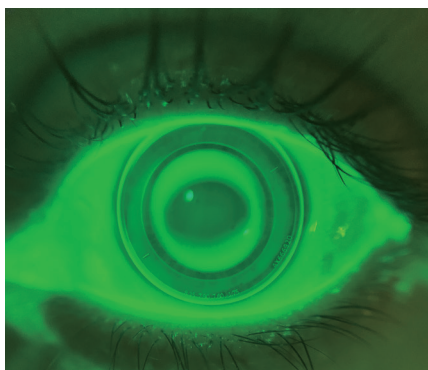

OK lens fitting

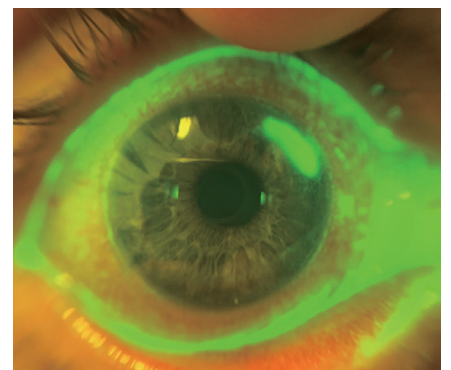

Marginal Keratitis

Specification

VPA-200

Magnification	10X
Illumination	White (2 level of brightness), Cobalt blue
Filter	Flipable yellow filter
Working Distance	15~20 mm
Image Capture	Still image, video
Working App	Smartphone camera app/VisuDoc (optional)
Working time	5 hours
Power	Rechargeable Li-ion battery
Recharging Time	1.5 hour
Dimension	6X4X4 (cm)
Net Weight	59g

Packing Details:



QuikVue Plus adaptor



zipper box



USB/Type C cable



user guide QR code card



VisuScience Meditech Co., Ltd.

Add: Room 718, No. 208, Guangyi Road, Wuxi Jiangsu 214016, China

Tel: +86-510-85757880

E-mail: info@visu-science.com

Web: www.visu-science.com



Scan to Learn More